

[Custom View Settings](#)

Topic 1 - Exam A

Question #1 Topic 1

What is a primary benefit of using data replication in a data center environment?

- A. Provides data archiving capability
- B. Reduces the cost of storage
- C. Ensures business continuity
- D. Reduces duplicate data

**Correct Answer: C**

*Community vote distribution*



**mo7amed\_3id** 2 months ago

**Selected Answer: C**

C is a correct answer  
upvoted 1 times

Question #2 Topic 1

What is true about an OSD storage system?

- A. Numerous objects can be stored in a single file system folder of OSD.
- B. Objects are created based on the name and location of the file.
- C. One object can be placed inside another object to save storage space.
- D. Objects contain user data, related metadata, and user defined attributes of data.

**Correct Answer: D**

*Community vote distribution*



**mo7amed\_3id** 2 months ago

**Selected Answer: D**

D is a correct answer  
upvoted 1 times

In a data archiving environment, which component scans primary storage to find the files that are required to archive?

- A. Archive stub file
- B. Archive agent
- C. Archive storage
- D. Archive database server

**Correct Answer: B**

*Community vote distribution*



  **mo7amed\_3id** 2 months ago

**Selected Answer: B**

B is a correct answer  
upvoted 1 times



What is the function of a control plane in the SDDC?

- A. Performs financial operations used to calculate CAPEX
- B. Performs processing and Input output operations
- C. Performs administrative operations and for communicating messages
- D. Performs resource provisioning and provides the programming logic and policies

**Correct Answer: D**

*Community vote distribution*



  **mo7amed\_3id** 2 months ago

**Selected Answer: D**

D is correct answer  
upvoted 1 times

What is an impact of a Denial of Service (DoS) attack?

- A. Compromises user accounts and data to malicious insiders
- B. Hijacks privileges to compromise data security
- C. Prevents legitimate users from accessing IT resources or service
- D. Duplicates user credentials to compromise data security

**Correct Answer: C**

*Community vote distribution*



**mo7amed\_3id** 2 months ago

**Selected Answer: C**

C is correct

upvoted 1 times

In a modern data center environment, which mechanism secures internal assets while allowing Internet-based access to selected resources?

- A. Virtual private network
- B. Demilitarized zone
- C. WWN zoning
- D. Virtual local area network

**Correct Answer: B**

*Community vote distribution*



**mo7amed\_3id** 2 months ago

**Selected Answer: B**

B is correct

upvoted 1 times

What is the total usable data storage capacity in this scenario: a RAID 6 array with four 250 GB disks

- A. 500 GB
- B. 1000 GB
- C. 250 GB
- D. 750 GB

**Correct Answer:** A

*Community vote distribution*



**mo7amed\_3id** 2 months ago

**Selected Answer:** A

A is Correct  
upvoted 1 times

Which is a characteristic of RAID 6?

- A. Double parity
- B. Single parity
- C. All parity stored on a single disk
- D. Parity not used

**Correct Answer:** A

*Community vote distribution*



**mo7amed\_3id** 2 months ago

**Selected Answer:** A

A is correct  
upvoted 1 times

**mo7amed\_3id** 2 months ago

A is correct  
upvoted 1 times

Refer to the Exhibit:

### FC Protocol Stack

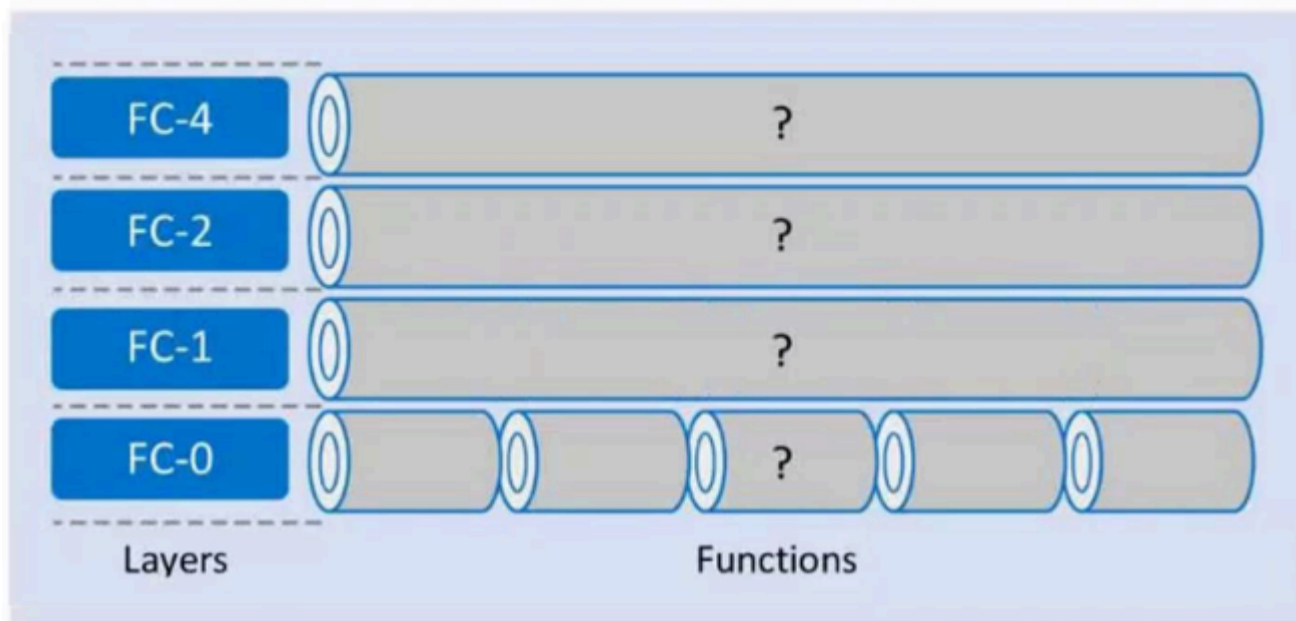

Which functions align with each layer of the FC Protocol Stack using the following order: FC-4, FC-2, FC-1, and FC-0?

A. Physical -

Encode and decode -

Routing and flow control -

Mapping interface

B. Physical -

Encode and decode -

Common services -

Mapping interface

C. Mapping interface -

Routing and flow control -

Encode and decode -

Physical

D. Mapping interface -

Common services -

Encode and decode -

Physical

**Correct Answer: D**

Community vote distribution

C (100%)

**rcexamtopics23** 1 week, 4 days ago

**Selected Answer: C**

C. Mapping interface - Routing and flow control - Encode and decode - Physical

upvoted 1 times

**mo7amed\_3id** 2 months ago

**Selected Answer: C**

C is the correct answer

upvoted 1 times

What set of factors are used to calculate the disk service time of a hard disk drive?

A. Seek time -

Rotational latency -

Data transfer rate

B. Seek time -

Rotational latency -

I/O operations per second

C. Seek time -

Rotational latency -

RAID level

D. Seek time -

Rotational latency -

Bandwidth

**Correct Answer: A**

*Community vote distribution*



**mo7amed\_3id** 2 months ago

**Selected Answer: A**

A is correct

upvoted 1 times

What is an accurate statement about data shredding?

A. A process to encrypt data

B. A process to decrypt data

C. A process to delete data

D. A process to reorganize data

**Correct Answer: C**

*Community vote distribution*



**mo7amed\_3id** 2 months ago

**Selected Answer: C**

C is correct

upvoted 1 times

What is an accurate statement about scale-out NAS?

- A. Creates a different file system for each node in the cluster
- B. Pools node resources in a cluster to work as multiple NAS devices
- C. Increases performance and capacity by adding nodes to the cluster
- D. Supports only data replication for protecting data across the nodes

**Correct Answer: C**

*Community vote distribution*



 **mo7amed\_3id** 2 months ago

**Selected Answer: C**

C is correct

upvoted 1 times

Refer to the Exhibit:

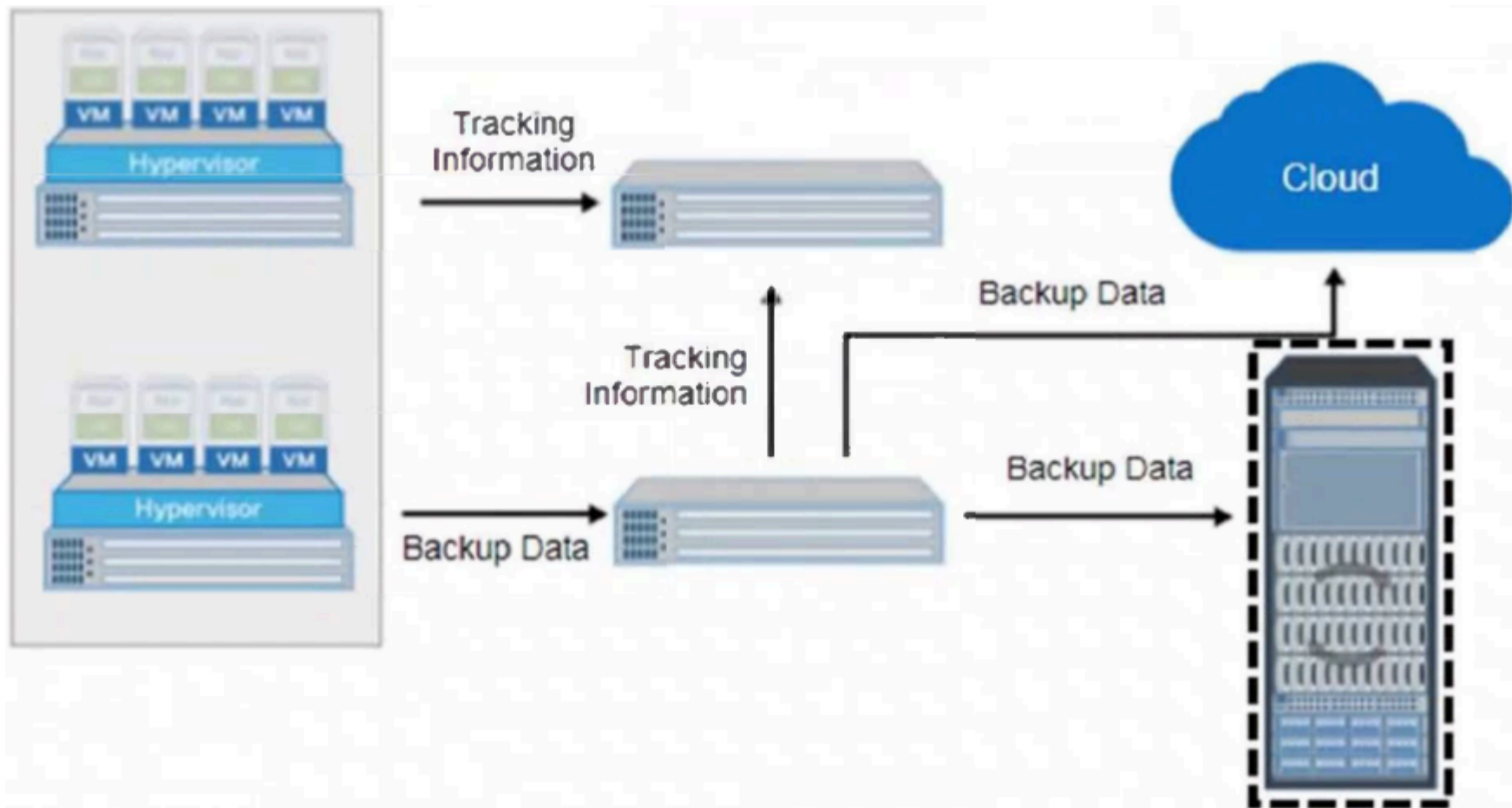

What is the name of the selected backup architecture component?

- A. Backup Device
- B. Storage Node
- C. Backup Client
- D. Backup Server

**Correct Answer: D**

Community vote distribution

A (100%)

**rcexamtopics23** 1 week, 4 days ago

**Selected Answer: A**

Backup Device es the Backup Target  
upvoted 1 times

What is true about a software defined data center?

- A. IT resource components are virtualized except commodity hardware used to create resource pools
- B. Management operations are dependent of underlying hardware configuration
- C. Services listed in the service portal are updated automatically using orchestration tool
- D. Management functions are moved to an external software controller

**Correct Answer: C**



Refer to the Exhibit:

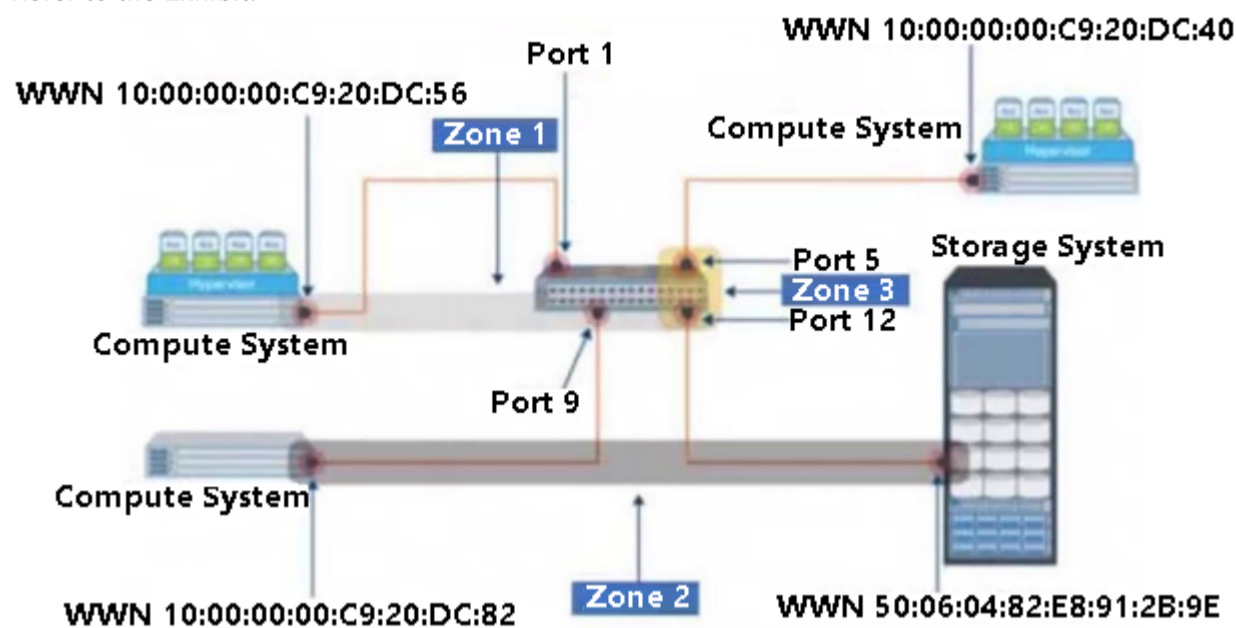

Select the option that represents the three Zone Types for each of the labeled zones.

A. Zone1: Port -

Zone2: WWW -

Zone3: Fabric

B. Zone1: Mixed -

Zone2: WWW -

Zone3: Port

C. Zone1: Fabric -

Zone2: WWW -

Zone3: Mixed

D. Zone1: WWW -

Zone2: Mixed -

Zone3: Port

**Correct Answer: B**

An organization has two data centers separated by a distance of 1600 km. They want to replicate between these data centers for disaster recovery purposes. They are concerned that this will impact application response time.

Which solution will address this concern?

A. Asynchronous remote replication

B. Storage-based COFW snapshot replication

C. Synchronous remote replication

D. Storage-based ROW snapshot replication

**Correct Answer: A**



What is a function of a continuous data protection (CDP) appliance?

- A. Migrates deduplicated data from the source volume to the target volume during replication
- B. Intercepts writes to the production volume and splits each write into two copies
- C. Runs data protection software and manages replications within and across data centers
- D. Stores all data that has changed from the time the replication session started

**Correct Answer:** D

Community vote distribution

B (100%)

  **rcexamtopics23** 1 week, 4 days ago

**Selected Answer:** B

A Continuous Data Protection (CDP) appliance captures changes to data in real-time or near-real-time by intercepting writes to the production volume and making copies of each change. This allows for continuous backups and the ability to restore data to any point in time.

upvoted 1 times

What is a key function of the orchestration layer in a modern data center architecture?

- A. Provides a unified view to manage the resources across the data centers
- B. Enables automatic updates of offerings listed in the service catalog with pre-defined workflows
- C. Allows automated arrangement, coordination, and management of resource provisioning
- D. Interacts directly with physical components across layers to begin provisioning

**Correct Answer:** C

Which type of zoning does the "X" represent?

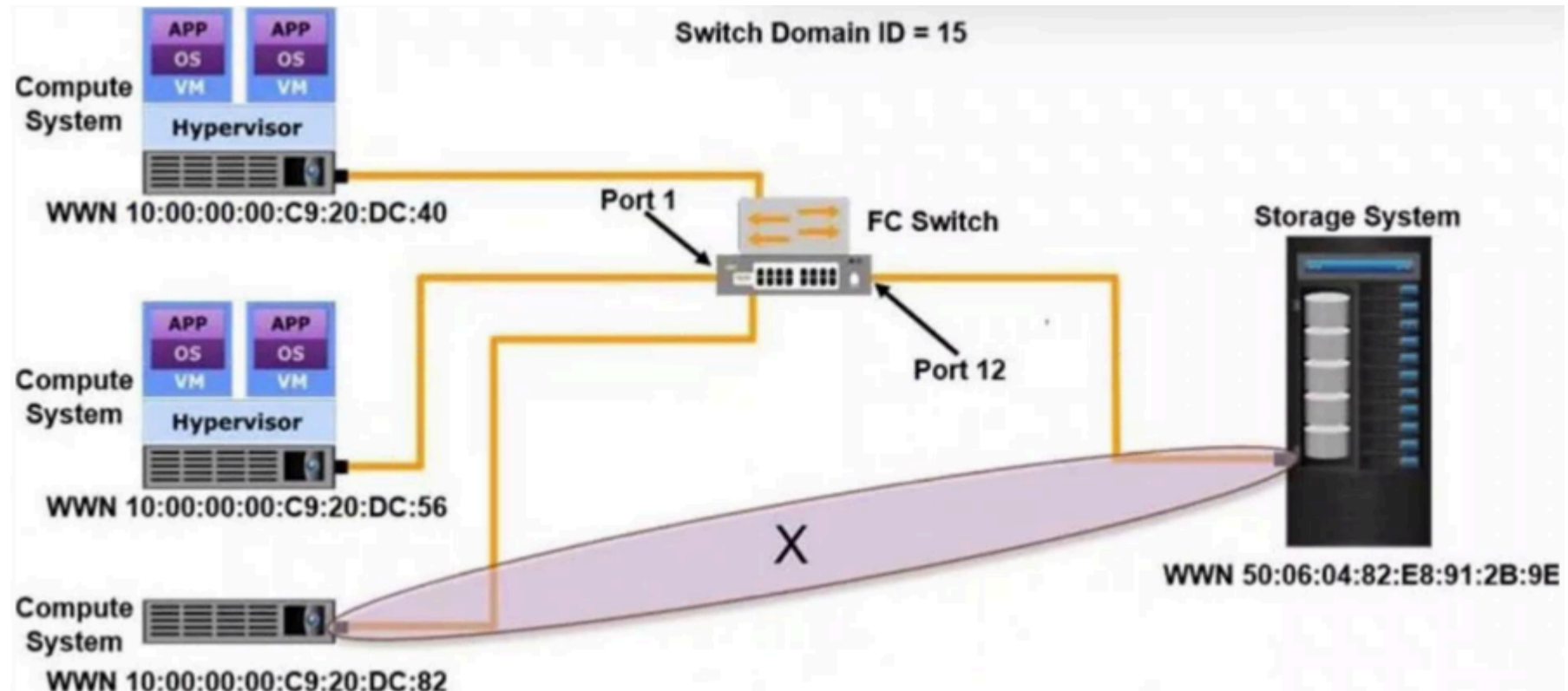

- A. Fabric zoning
- B. WWN zoning
- C. Port zoning
- D. Mixed zoning

Correct Answer: B

What type of process, when performed on data, would produce the result shown?

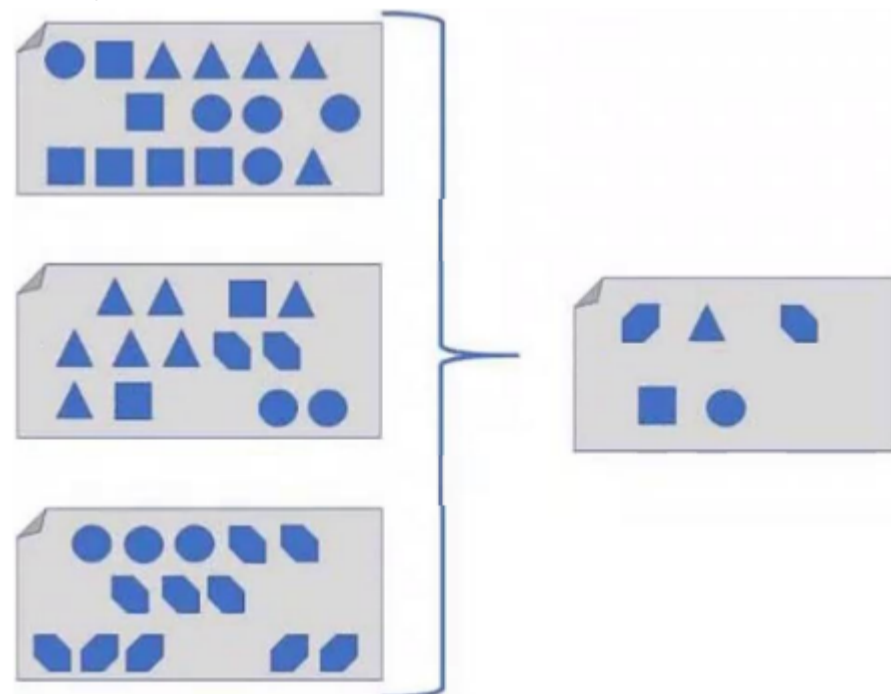

- A. Deduplication
- B. Replication
- C. Migration
- D. Archive

Correct Answer: A

Cloud tiering is the part of which tier?

- A. Policy
- B. Primary Storage
- C. Application
- D. Secondary Storage

**Correct Answer: D**

Which components comprise a Fibre Channel SAN?

- A. TOE HBA -  
Gateways -  
CAT6 cables
- B. FC HBA -  
Switches -  
Fiber optic cables
- C. FC HBA -  
Gateways -  
Fiber optic cables
- D. TOE HBA -  
Switches -  
CAT6 cables

**Correct Answer: B**

Which intelligent storage system component performs replication and storage management functions?

- A. Solid state drive
- B. Controller
- C. Storage class memory
- D. Front-end ports

**Correct Answer: B**